



















NESTING TABLES

UPDATED

NESTING SIDE TABLE ø 40 cm										
	FUVOLST02S frame - structure	<table border="1"> <tr><td></td><td>A01 white</td></tr> <tr><td></td><td>A31 charcoal</td></tr> </table>		A01 white		A31 charcoal	choose table top choisissez le plateau kies tafelblad			
		A01 white								
	A31 charcoal									
FUVOLTOP00 table top plateau tafelblad	<table border="1"> <tr><td></td><td>W62 teak</td></tr> <tr><td></td><td>K02 bianco</td></tr> <tr><td></td><td>K14 taupegrey</td></tr> <tr><td></td><td>K31 charcoal</td></tr> </table>		W62 teak		K02 bianco		K14 taupegrey		K31 charcoal	€ 315 € 695
	W62 teak									
	K02 bianco									
	K14 taupegrey									
	K31 charcoal									

frame: 3.3 kg, 7.3 lbs nett
5.6 kg, 12.3 lbs gross
47 x 47 x 64 cm, 0.1 cbm

teak top: 1 kg, 2.2 lbs nett
2 kg, 4.4 lbs gross
47.5 x 47.5 x 10.5 cm

ceramic top: 3.3 kg, 7.3 lbs nett
5 kg, 11 lbs gross
47.5 x 47.5 x 10.5 cm



40 cm - 15.7"























40 cm - 15.7"

43.8 cm - 15.5"

55 cm - 21.7"

Teak

Ceramic

NESTING SIDE TABLE ø 50 cm										
	FUVOLST03S frame - structure	<table border="1"> <tr><td></td><td>A01 white</td></tr> <tr><td></td><td>A14 lava</td></tr> <tr><td></td><td>A31 charcoal</td></tr> </table>		A01 white		A14 lava		A31 charcoal	choose table top choisissez le plateau kies tafelblad	
		A01 white								
	A14 lava									
	A31 charcoal									
FUVOLTOP01 table top plateau tafelblad	<table border="1"> <tr><td></td><td>W62 teak</td></tr> <tr><td></td><td>K02 bianco</td></tr> <tr><td></td><td>K14 taupegrey</td></tr> <tr><td></td><td>K31 charcoal</td></tr> </table>		W62 teak		K02 bianco		K14 taupegrey		K31 charcoal	€ 395 € 745
	W62 teak									
	K02 bianco									
	K14 taupegrey									
	K31 charcoal									

frame: 2.8 kg, 6.2 lbs nett
5.8 kg, 12.8 lbs gross
56.5 x 56.5 x 54.5 cm, 0.2 cbm

teak top: 1.5 kg, 3.3 lbs nett
3 kg, 6.6 lbs gross
57.5 x 57.5 x 12 cm

ceramic top: 5.2 kg, 11 lbs nett
7.5 kg, 16.5 lbs gross
57.5 x 57.5 x 12 cm

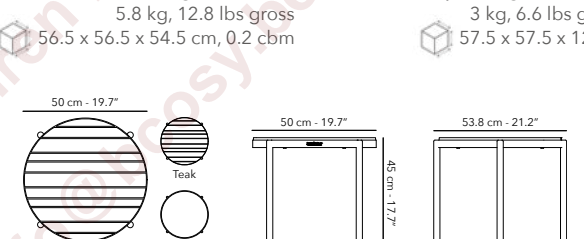

50 cm - 19.7"



















50 cm - 19.7"

53.8 cm - 21.2"

45 cm - 17.7"

Teak

Ceramic

NESTING COFFEE TABLE ø 60 cm										
	FUVOLST06S frame - structure	<table border="1"> <tr><td></td><td>A01 white</td></tr> <tr><td></td><td>A31 charcoal</td></tr> </table>		A01 white		A31 charcoal	choose table top choisissez le plateau kies tafelblad			
		A01 white								
	A31 charcoal									
FUVOLTOP02 table top plateau tafelblad	<table border="1"> <tr><td></td><td>W62 teak</td></tr> <tr><td></td><td>K02 bianco</td></tr> <tr><td></td><td>K14 taupegrey</td></tr> <tr><td></td><td>K31 charcoal</td></tr> </table>		W62 teak		K02 bianco		K14 taupegrey		K31 charcoal	€ 445 € 795
	W62 teak									
	K02 bianco									
	K14 taupegrey									
	K31 charcoal									

frame: 3.2 kg, 7 lbs nett
6.4 kg, 14.1 lbs gross
67 x 67 x 42.5 cm, 0.2 cbm

teak top: 2.2 kg, 4.9 lbs nett
4 kg, 8.8 lbs gross
68 x 68 x 10.5 cm

ceramic top: 3 kg, 6.6 lbs nett
3.5 kg, 7.7 lbs gross
68 x 68 x 10.5 cm

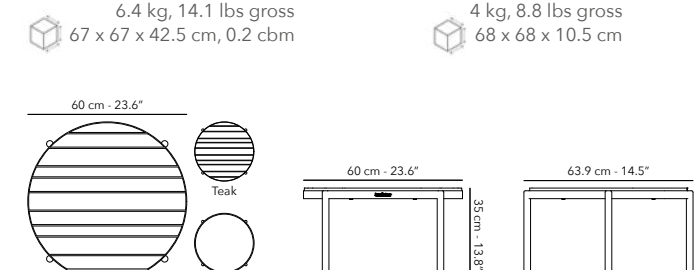

60 cm - 23.6"

60 cm - 23.6"

63.9 cm - 14.5"

35 cm - 13.8"









Teak

Ceramic

NESTING TABLES



NESTING COFFEE TABLE ø 75 cm

	FUVOLST04S frame - structure		A01 white	choose table top choisissez le plateau kies tafelblad	€ 495
			A14 lava		
			A31 charcoal		
	FUVOLTOP03 table top plateau tafelblad		W62 teak	€ 995	
			K02 bianco		
			K14 taupegrey		
			K31 charcoal		







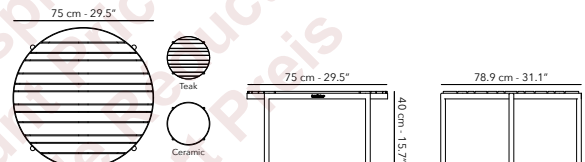

frame: 4 kg, 8.8 lbs nett
 8.3 kg, 18.3 lbs gross
 83 x 83 x 47 cm, 0.3 cbm

teak top: 3.7 kg, 8.2 lbs nett
 6 kg, 13.2 lbs gross
 81 x 81 x 6 cm

ceramic top: 12 kg, 26 lbs nett
 16 kg, 35.3 lbs gross
 81 x 81 x 6 cm



NESTING COFFEE TABLE ø 90 cm

	FUVOLST05S frame - structure		A01 white	choose table top choisissez le plateau kies tafelblad	€ 595
			A14 lava		
			A31 charcoal		
	FUVOLTOP04 table top plateau tafelblad		W62 teak	€ 1.245	
			K02 bianco		
			K14 taupegrey		
			K31 charcoal		

frame: 4.2 kg, 9.3 lbs nett
 10 kg, 22 lbs gross
 99 x 99 x 42 cm, 0.4 cbm

teak top: 5.2 kg, 11.5 lbs nett
 8.5 kg, 18.7 lbs gross
 97 x 97 x 10.5 cm

ceramic top: 18 kg, 39.7 lbs nett
 23 kg, 50.7 lbs gross
 97 x 97 x 10.5 cm

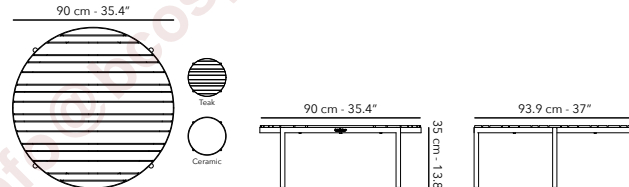



NESTING TABLES

TARO COFFEE TABLE ROUND ø 90 cm

NEW

	FUTARLT13 frame - structure		A03 linen	€ 995
---	--------------------------------	---	-----------	-------

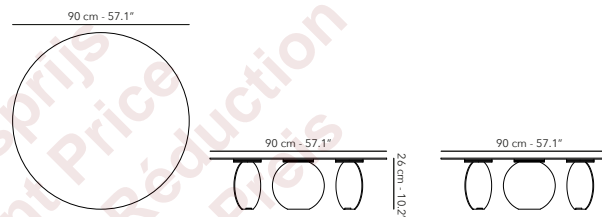
 95 x 95 x 31 cm, 0,3 cbm



TARO COFFEE TABLE ORGANIC 145 x 100 cm

NEW

	FUTARLT14 frame - structure		A03 linen	€ 1.195
---	--------------------------------	---	-----------	---------

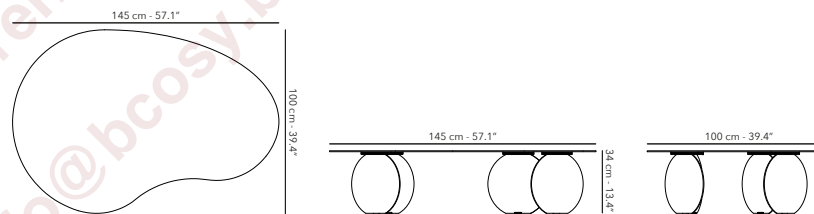

 150 x 105 x 39 cm, 0,6 cbm





NESTING TABLES

KOBE SIDE TABLE ø 40 cm

NEW

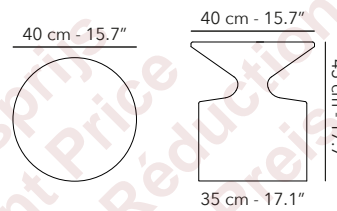

	FUKOBST11 Kobe side table small		W62 teak	€ 995
---	------------------------------------	---	----------	-------





frame: 19.1 kg, 42 lbs nett
21.1 kg, 46.5 lbs gross
 44 x 44 x 50 cm, 0.1 cbm

KOBE SIDE TABLE ø 50 cm

NEW

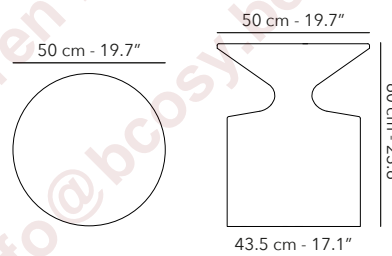
	FUKOBST12 Kobe side table large		W62 teak	€ 1.495
---	------------------------------------	---	----------	---------



frame: 38.3 kg, 84.4 lbs nett
41.3 kg, 91 lbs gross
 54 x 54 x 65 cm, 0.2 cbm

DUNCAN

	DEDECDUN.01 Duncan teak block		W62 teak	€ 995
---	----------------------------------	---	----------	-------

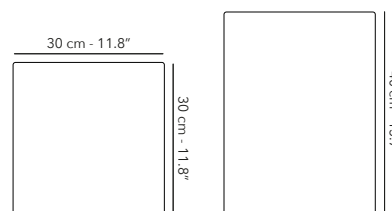

frame: 24 kg, 52.9 lbs nett
25 kg, 55.1 lbs gross
 30 x 30 x 40 cm

MAINTENANCE & PROTECTION - ONDERHOUD & BESCHERMING

TEAK			ALUMINIUM																		
	<p>FUCARECL-W62-1L FUCAREPR-W62-1L natural teak care kit</p> <p>Suitable for Noa, Nature, Tecca and Flexx collection & Dune dining chair</p> 	<p>teak cleaner 1000ml teak protector 1000ml</p>	<p>€ 129</p>		<p>SPCOR-12ML corrector pen</p>	<table border="1"> <tr><td></td><td>A01 white</td></tr> <tr><td></td><td>A03 linen</td></tr> <tr><td></td><td>A11 taupe</td></tr> <tr><td></td><td>A14 lava</td></tr> <tr><td></td><td>A30 anthracite</td></tr> <tr><td></td><td>A31 charcoal</td></tr> <tr><td></td><td>A32 black</td></tr> </table>		A01 white		A03 linen		A11 taupe		A14 lava		A30 anthracite		A31 charcoal		A32 black	<p>€ 45</p>
	A01 white																				
	A03 linen																				
	A11 taupe																				
	A14 lava																				
	A30 anthracite																				
	A31 charcoal																				
	A32 black																				
	<p>FUCARE-W64-75CL sable teak care kit</p> <p>Suitable for Legna collection</p> 	<p>exterior oil 750ml exterior cleaner 250ml scouring sponge gloves & brush cloth red polishing pad & holder</p> <p>exterior oil 750ml exterior cleaner 250ml éponge à récurer gants & brosse chiffon tampon de polissage rouge porte-tampon</p> <p>exterior oil 750ml exterior cleaner 250ml schuurspons handschoenen & borstel rode polierpad & houder</p>	<p>€ 129</p>	<p>Quick-drying liquid paint with built-in brush for powder-coated surfaces. Ideal for retouching small surface traces (scratches, wear).</p> <p>Peinture liquide à séchage rapide avec pinceau intégré pour les surfaces thermolaqué. Idéale pour retoucher les petites marques de surface (rayures, abrasion).</p> <p>Sneldrogende vloeibare verf met ingebouwde borstel voor gepoederlakte oppervlakken. Ideaal voor het retoucheren van kleine oppervlaktesporen (krassen, slijtage).</p>																	
	<p>FUCARE-W68-75CL black teak care kit</p> <p>Suitable for Nero collection</p> 	<p>exterior oil 750ml exterior cleaner 250ml scouring sponge gloves & brush cloth red polishing pad & holder</p> <p>exterior oil 750ml exterior cleaner 250ml éponge à récurer gants & brosse chiffon tampon de polissage rouge porte-tampon</p> <p>exterior oil 750ml exterior cleaner 250ml schuurspons handschoenen & borstel rode polierpad & houder</p>	<p>€ 129</p>																		

MATERIALS - MATERIAUX - MATERIALEN

NATURAL STONE - PIERRE NATURELLE - NATUURSTEEN umbrella base - base du parasol - parasolvoet



G04 light grey granite



G13 Egyptian sandstone



G32 black granite

Extremely strong and low porous. Stain repellent, UV-resistant, and resistant to heat, frost and mold. Due to its natural composition, variations in colour and pattern are inherent to each stone.

Extrêmement solide et peu poreux. Il est antitache, résistant aux UV, à la chaleur, au froid et au champignon. En raison de sa composition naturelle, les variations de couleur et de motif sont inhérentes à chaque pierre.

Extreem sterk en weinig poreus. Vlekafstotend, UV-bestendig en bestand tegen hitte, vorst, en schimmel. Door de natuurlijke samenstelling zijn variaties in kleur en patroon inherent aan elke steen.

STEEL - ACIER - STAAL umbrella base - base du parasol - parasolvoet

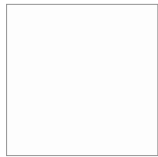

S01 white



S03 linen



S31 charcoal

Hot galvanised powder coated steel plates, heavy and rust free.

Tôle d'acier galvanisé à chaud et thermolaqué, lourd et inoxydable.

Warm verzinkte en gepoederlakte staalplaat, zwaar en roestvrij.

CONCRETE - BÉTON - BETON umbrella base - base du parasol - parasolvoet



B01 white



B03 linen



B06 hazel



B30 anthracite

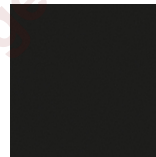

B32 black

Robust and long-lasting, resistant to frost and heat.

Robuste et durable, résistant au froid et à la chaleur.

Robuust en duurzaam, bestand tegen vorst en hitte.

MATERIALS - MATERIAUX - MATERIALEN

TEXTILENE - TEXTILÈNE - TEXTILEEN frame - structure



T02 silver



T30 anthracite

Sunbrella® sling.
Stain and water repellent with a padded finish.

Sunbrella® sling.
Antitaches et hydrofuges avec une finition rembourrée.

Sunbrella® sling.
Vlek- en waterafstotend met een gewatteerde afwerking.

ROPE - CORDE - TOUW frame - structure



R02 silver



R03 linen

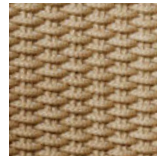

R04 almond



R05 seal

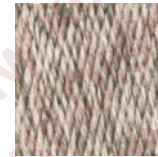

R11 artichoke

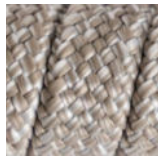

R12 cream

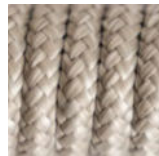

R13 sand



R14 brown

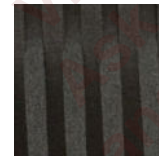

R30 anthracite

UV-resistant polyolefin, woven by hand.

Polyoléfine résistante aux UV, tissée à la main.

UV bestendig polyolefin, hand geweven.

ALUMINIUM frame - structure



A01 white



A03 linen



A04 almond



A14 lava



A30 anthracite



A31 charcoal

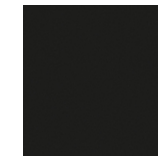

A32 black



A69 lime

Powdercoated aluminium.

Aluminium thermolaqué.

Gepoederlakt aluminium.

MATERIALS - MATERIAUX - MATERIALEN

CERAMIC - CÉRAMIQUE - KERAMIEK frame - structure



K02 bianco

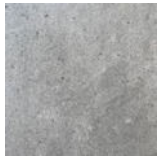

K14 taupegrey

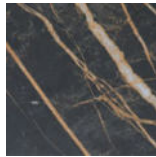

K31 charcoal

Made of natural clays and mineral colours which are pressed and fired to make a high-performing surface. Thickness of 12 mm, 0,5".

Fait d'argiles naturelles et de couleurs minérales qui sont pressées et cuites pour créer une surface haute performance. Épaisseur de 12 mm, 0,5".

Gemaakt van natuurlijke klei en minerale kleuren die worden geperst en gebakken om een hoogwaardig oppervlak te maken. Dikte van 12 mm, 0,5".

MINERAL STONE - PIERRE MINÉRALE - MINERAALSTEEN frame - structure



X01 mist

A mixture of chalk and concrete applied by hand and spatula. Silky texture, water-repellent & waterproof.

Mélange de chaux et de béton appliqué à la main et à la spatule. Texture soyeuse, hydrofuge et imperméable.

Een mengsel van kalk en beton dat met de hand en een spatel wordt aangebracht. Zijdeachtige textuur, waterafstotend en waterdicht.

WICKER - OSIER frame - structure

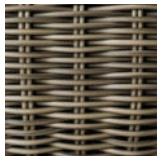

F16 cottage



R32 black

High quality, synthetic fibre that is woven by hand. UV-resistant, resistant to great variations in temperature. Sea- & chlorine water repellent, scratch resistant.

Fibre synthétique de haute qualité, tissée à la main. Résiste aux UV et aux fortes variations de température. Imperméable à l'eau de mer et au chlore, résistant aux rayures.

Hoogwaardige, synthetische vezel die met de hand wordt geweven. UV-bestendig, bestand tegen grote temperatuurschommelingen. Zee- en chloorwaterafstotend, krasbestendig.

WOOD - BOIS - HOUT frame - structure



W62 teak

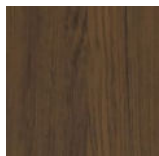

W64 sable teak

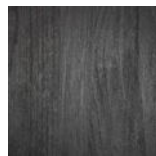

W68 black teak

W62: teak with matt finish.

W64 & W68: teak with brushed finish and coloured coating

W62: teak à finition mate

W64 & W68: teak à finition brossée et revêtement coloré

W62: teak met matte afwerking

W64 & W68: teak met geborstelde afwerking en gekleurde coating

This price list includes recommended retail prices in EURO and replaces all previous versions.
Valid from 01.10.2022.

WARRANTY

We provide, barring different agreement of more or less, a maximum warranty of 2 years on our products. The warranty takes effect on the day that the product is purchased from an official commercial partner of Jardinico® Parasols (date of invoicing). The warranty applies to production and/or materials errors, caused by normal use. The product shall not be replaced in its entirety if a defective part and/or component can be replaced. Jardinico® Parasols shall by no means be held to provide a warranty if the defects are the result of improper or incorrect use by the final user. Please consult the general terms and conditions on our website to learn more about the exceptions to the warranty.

The representation of colours, dimensions and weights may differ from reality, as may variations when a product is handmade. Prices, dimensions and technical details are subject to change without notice. Jardinico is not responsible for any printing and/or typing errors. Our general sales conditions always apply - see website.
Jardinico® Parasols BV. All rights reserved.

EXCEPTIONS TO THE WARRANTY

The warranty applies to production and/or materials errors, caused by normal use. The product shall not be replaced in its entirety if a defective part and/or component can be replaced. This warranty does not cover defects caused by incorrect assembly, defects as a result of changes by the buyer, intentional damages, incorrect use, abuse or negligence, not buying an associated base or ground anchor and normal wear and tear as a result of ageing and labour or assembly costs. The replacement of components shall be carried out by the final user or the retailer. JARDINICO Parasols limits itself, as the occasion arises, to making the components and/or parts to be replaced available to the said final user or retailer.

Our company reserves the right to remove a model from our collection at any time and without prior notice. All our spare parts remain in stock up to 2 years after the product has been discontinued. If the buyer establishes not to dispose of user instructions or user instructions that are unclear to the buyer then the buyer must report this immediately when making the purchase. If the buyer proceeded with installation of the purchased product, without the said notification, then the warranty expires. Products purchased during the sale before the end of a collection are never replaced or repaired. Parasol ribs fall outside the present warranty.

DAMAGE DUE TO WIND DOES NOT FALL UNDER OUR LIMITED WARRANTY.

Natural disasters (including but not limited to wind, hurricanes, tornadoes and storms) and natural aspects of the ageing process do not fall under this warranty and are therefore not qualified as a defect. Not a single parasol, regardless of the size or the weight, can be left unattended in an open position. In case of windy circumstances it is recommended to close the parasols, to remove them from their base and to store or position them horizontally. This shall reduce the chance of damage to your parasol and other possessions or belongings. The warranty does not cover discolouration, the bleeding of colours, changes in textures, scratches, breaks in or damages to lacquer due to use and/or defective maintenance / incorrect use. This enumeration is not exhaustive.

In due course natural teak turns grey. The surface may show discolouration. Appropriate treatments are available to ensure that the parasols retain their original appearance. Do not let dirt accumulate at the base. It is recommended to clean with mild soap and water. Never leave the base of the parasol standing in water. In case of use at the beach or an indoor pool salt and chlorine may accumulate on the powder coating and affect the finishing. To make sure that the base continues looking its best, you can best store it if it is not being used for a longer period of time.

The buyer expressly acknowledges to be informed of the above and also acknowledges that they cannot be qualified as a defect within the meaning of Section 1649ter of the Belgian Civil Code. The buyer moreover expressly acknowledges to have been informed of the fact that during the treatment of fabrics and metals colour differences may occur. The mere establishment of these kinds of colour differences shall never give cause to refusal of a delivery, unless the contrary was stipulated in advance and in writing.

Ce tarif contient des prix de vente recommandés en EURO et remplace toutes les versions précédentes.
Valable à la partir du 01.10.2022.

GARANTIE

Nous accordons, sauf autre accord contraire supérieur ou inférieur, maximum 2 ans de garantie sur nos produits. La garantie prend effet le jour où le produit est acheté auprès d'un partenaire officiel de Jardinico® Parasols (date de facturation). La garantie s'applique aux défauts de production et/ou aux défauts de matériau engendrés par un usage normal. Le produit ne sera pas entièrement remplacé si la pièce et/ou le composant défectueux peut être remplacé. Jardinico® Parasols n'offre dans aucun cas une garantie lorsque les défauts sont la conséquence d'un usage impropre ou abusif par l'utilisateur final. Veuillez consulter les conditions générales sur notre site web pour en savoir plus sur les exceptions à la garantie.

La reproduction des couleurs, les mesures et les poids peuvent différer de la réalité ainsi que des variations chaque fois qu'un produit est fait à la main. Les prix, dimensions et détails techniques peuvent être sujets à changement sans préavis. Jardinico n'est pas responsable des erreurs d'impression et/ou de frappe. Nos conditions générales de vente sont toujours

EXCLUSIONS DE GARANTIE

La garantie s'applique uniquement aux défauts de production et/ou aux défauts de matériau engendrés par un usage normal. Le produit ne sera pas remplacé si la pièce et/ou le composant défectueux peut être remplacé. La garantie ne couvre pas les défauts causés par une mauvaise installation, par des modifications effectuées par l'acheteur, ni les défauts intentionnels, ou causés par une mauvaise utilisation, une utilisation abusive ou par la négligence. Elle ne couvre pas non plus les défauts causés par le non-achat d'un pied ou d'une base adaptée, ni ceux causés par l'usure normale au fil du temps et de l'utilisation. Enfin, elle ne couvre pas non plus les frais d'installation. Le remplacement de pièces détachées sera effectué par l'utilisateur final ou par le commerçant de détail. Dans ce cas, JARDINICO Parasols s'engage seulement à mettre les pièces détachées et/ou les composants à remplacer à la disposition de l'utilisateur final ou du commerçant de détail. Notre entreprise se réserve le droit de retirer un modèle de sa collection, à tout moment, et sans notification préalable. Toutes les pièces détachées de réserve restent en stock 2 ans après l'arrêt de la production du produit concerné.

Si l'acheteur indique ne pas être en possession d'un mode d'emploi ou être en possession d'un mode d'emploi imprécis pour lui, il doit immédiatement le dire au moment de l'achat. Si l'acheteur procède néanmoins à l'installation du produit acheté, sans avoir notifié l'absence de mode d'emploi, la garantie ne pourra pas être appliquée. Les articles achetés en liquidation de fin de série ne sont ni remplacés ni remboursés. Les baleines de parasols sont exclues de la garantie.

LES DÉGÂTS CAUSÉS PAR LE VENT SONT EXCLUS DE LA GARANTIE.

Les catastrophes naturelles (y compris mais non limitées au vent, aux ouragans, aux tornades et aux tempêtes) ainsi que les aspects naturels du vieillissement sont exclus de la garantie et ne peuvent donc être considérés comme étant à l'origine de défauts. Aucun parasol, peu importe la taille ou le poids, ne doit être laissé en position ouverte sans surveillance. En cas vents violents, il est fortement conseillé de fermer les parasols, de les enlever de leur pied et de les ranger à l'horizontale. Cela réduit le risque de dégâts sur votre parasol et sur d'autres objets et biens.

La garantie ne couvre pas la coloration, la décoloration, la modification de la texture, les rayures, les déchirures ou les dégâts à la peinture en lien avec l'utilisation et/ou le manque d'entretien ou la mauvaise utilisation. Cette liste est non exhaustive.

Avec le temps, le teck devient naturellement grisâtre. La surface peut prendre une certaine coloration. Il existe des traitements adaptés permettant de conserver l'état original des parasols. N'entassez aucun déchet au pied du parasol. Il est recommandé de nettoyer le parasol au savon doux et à l'eau. Ne laissez jamais le pied du parasol dans l'eau. En cas d'utilisation à la plage ou en piscine couverte, le sel et le chlore peuvent s'attaquer au revêtement et l'endommager. Pour garder le pied dans son état d'origine, il est recommandé de le ranger à l'abri lorsqu'il n'est pas utilisé sur une période prolongée.

L'acheteur déclare avoir été informé des questions traitées ci-dessus et accepte que celles-ci ne pourront pas être considérées comme non-conforme au contrat au sens de l'article 1649ter du Code civil.

L'acheteur déclare en outre être au courant du fait que le traitement de tissus et de métaux peut engendrer des variations de couleurs. L'identification simple de ces variations de couleurs ne peut en aucun cas donner lieu au refus de livraison, sauf accord contraire convenu au préalable.

Deze prijslijst bevat aanbevolen verkoopprijzen in EURO, en vervangt alle eerdere versies.
Geldig vanaf 01.10.2022.

GARANTIE

Wij verlenen, behoudens andersluidende overeenkomst in meer of in min, maximaal 2 jaar garantie op onze producten. De garantie start op de dag dat het product door een officiële handelspartner van JARDINICO Parasols is aangekocht (facturatiedatum). De garantie is van toepassing op productie- en/of materiaalfouten, veroorzaakt ten gevolge van een normaal gebruik. Het product zal niet geheel vervangen worden als een defect onderdeel en/of component vervangen kan worden. JARDINICO Parasols zal geenszins tot garantie gehouden zijn wanneer de gebreken het gevolg zijn van een oneigenlijk of verkeerd gebruik door de eindgebruiker. Raadpleeg de algemene voorwaarden op onze website voor meer informatie over de uitzonderingen op de garantie.

De weergave van kleuren, afmetingen en gewichten kan afwijken van de werkelijkheid, evenals variaties wanneer een product handgemaakt is. Prijzen, afmetingen en technische details kunnen zonder voorafgaande kennisgeving worden gewijzigd. Jardinico is niet verantwoordelijk voor eventuele druk- en/of typfouten. Onze algemene verkoopvoorwaarden zijn altijd van toepassing - zie website. Jardinico® Parasols BV. Alle rechten voorbehouden

applicables - voir notre site web. Jardinico® Parasols BV. Tous les droits sont réservés.

UITZONDERINGEN VAN DE GARANTIE

De garantie is enkel van toepassing op productie- en/of materiaalfouten, veroorzaakt ten gevolge van een normaal gebruik. Het product zal niet vervangen worden als een defect onderdeel en/of component vervangen kan worden. Deze garantie dekt geen defecten veroorzaakt door onjuiste montage, defecten als gevolg van wijzigingen door de koper, opzettelijke schade, verkeerd gebruik, misbruik of nalatigheid, het niet aankopen van een bijpassende voet of grondanker en normale slijtage als gevolg van leeftijd en arbeid of montagekosten. Het vervangen van onderdelen zal uitgevoerd worden door de eindgebruiker of de detailhandelaar. Jardinico PARASOLS beperkt zich in dergelijk geval enkel tot het ter beschikking stellen van de te vervangen onderdelen en/of componenten van deze eindgebruiker of de detailhandelaar. Ons bedrijf behoudt zich het recht voor om op elk moment en zonder voorafgaande kennisgeving een Frame te schrappen uit de collectie. Al onze reserveonderdelen blijven in stock tot 2 jaar nadat het product werd stopgezet. Wanneer de koper vaststelt niet over een gebruiksaanwijzing of een voor hem/haar onduidelijke gebruiksaanwijzing te beschikken, moet dit onmiddellijk gemeld worden bij aankoop. Indien de koper is overgegaan tot installatie van het gekochte product, zonder deze voorafgaande melding, vervalt alle garantie. Artikelen aangekocht in uitverkoop voor einde collectie worden nooit vervangen of terugbetaald. Parasolribben vallen buiten de huidige garantie.

SCHADE DOOR WIND VALT NIET ONDER ONZE BEPERKTE GARANTIE.

Natuurrampen (inclusief maar niet beperkt tot wind, orkanen, tornado's en stormen) en natuurlijke aspecten van het verouderingsproces vallen niet onder deze garantie en worden daarom niet als een defect beschouwd. Geen enkele parasol, ongeacht de grootte of het gewicht, mag onbeheerd worden achtergelaten in open positie. Bij minder omstandigheden wordt aanbevolen om parasols te sluiten, van hun voet te verwijderen en op te bergen of horizontaal neer te leggen. Dit zal de kans op schade aan uw parasol en andere bezittingen of eigendommen verminderen. De garantie dekt geen verkleuring, het uitlopen van kleuren, veranderingen in texturen, krassen, barsten of schade in lak, ontstaan door gebruik en/of gebrekkig onderhoud/verkeerd gebruik. Deze opsomming is niet-limitatief. Na verloop van tijd wordt natuurlijk teak grijs. Het oppervlak kan verkleuring vertonen. Er zijn passende behandelingen beschikbaar om ervoor te zorgen dat de parasols hun oorspronkelijke uiterlijk behouden. Laat geen vuil opstapelen op de voet. Het wordt aanbevolen om te reinigen met milde zeep en water. Laat de voet van de parasol nooit in water staan. Bij gebruik aan het strand of een binnenzwembad kunnen zout & chloor zich gaan opstapelen op de powder coating en de afwerking aantasten. Om ervoor te zorgen dat de voet er op zijn best blijft uitzien, kan u ze best opbergen wanneer hij voor langere tijd niet wordt gebruikt. De koper erkent uitdrukkelijk op de hoogte te zijn van bovenstaande zaken en erkent eveneens dat deze niet beschouwd kunnen worden als een gebrek aan overeenstemming in de zin van artikel 1649ter BW. De koper erkent daarnaast uitdrukkelijk in kennis te zijn gesteld dat bij de bewerking van stoffen en metalen kleurverschillen kunnen bestaan. De loutere vaststellingen van dergelijke kleurverschillen zal nooit aanleiding kunnen zijn tot weigering van enige levering, tenzij het tegendeel schriftelijk en op voorhand bedongen werd.



tilt in height
inclinable en hauteur
kantelen in de hoogte



tilt left - right
inclinable à gauche et à droite
kantelen naar links en rechts



360° rotation
rotation de 360°
360° rotatie



knock down
à assembler
te monteren



modular
modulaire
modulair



adjustable feet
pieds réglables
verstelbare poten



aluminium connector
connecteur en aluminium



stackable
empilable
stapelbaar



foldable
pliable
plooibaar



Fast stock
uit voorraad leverbaar
disponibles sur stock
available on stock